

# High Performance BGA Cooling Solutions w/ Thermal Tape Attachment\*

DIGI-KEY PART # **ATS1296-ND**

ATS PART # ATS-55450K-C2-R0

## Features & Benefits

High efficiency cross-cut fin design provides low pressure drop characteristics

Large surface area increases heat sink performance

Designed for BGAs and surface mount packages

Comes preassembled with high performance thermal interface material

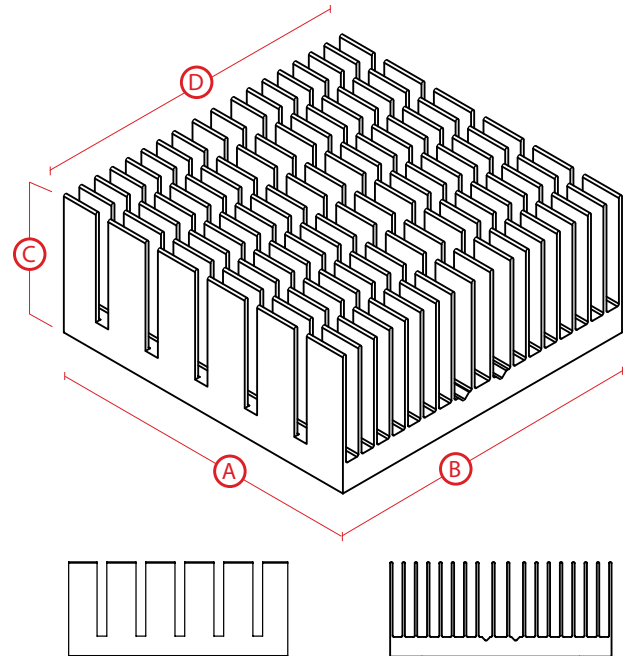

## Thermal Performance Table

AIR VELOCITY		THERMAL RESISTANCE	
FT/MIN	M/S	°C/W (UNDUCTED)	°C/W (DUCTED)
200	1.0	4.5	NA
300	1.5	NA	
400	2.0	NA	
500	2.5	NA	
600	3.0	NA	
700	3.5	NA	
800	4.0	NA	

## Product Details†

DIMENSION A	DIMENSION B	DIMENSION C§	DIMENSION D	TIM‡	FINISH
45	45	14.5	N/A	C675	BLACK-ANODIZED

For further technical information, please contact Advanced Thermal Solutions, Inc. at **1-781-769-2800** or **www.qats.com**

\* RoHS Compliant

‡ TIM = Thermal Interface Material

† Dimensions are measured in millimeters

◆ Dimensions A & B refer to component size

§ Dimension C = the height of the heat sink shown above and does not include the height of the attachment method



**ATS** ADVANCED THERMAL SOLUTIONS, INC.

Innovations in Thermal Management®



To place an order, please visit **www.digikey.com**